

Installation, Operation and Maintenance Manual

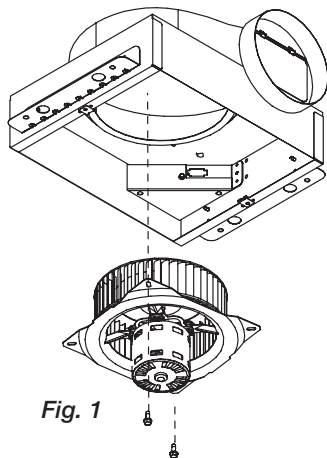

Prepare the Fan

1. If power assembly (motor and wheel) is not installed in housing, insert the electrical plug into fan socket, then slide wheel end of power assembly into fan housing and rotate clockwise until it is positioned under tabs. Align the holes and attach by using two sheet metal screws provided, shown in Fig. 1.

Ceiling Radiation Damper - CRD

1. If fan is to be used in a fire resistive membrane ceiling, a ceiling radiation damper must be used. Otherwise proceed to Install the Fan.
2. If the ceiling radiation damper is already mounted to the fan from the factory, proceed to Install the Fan.

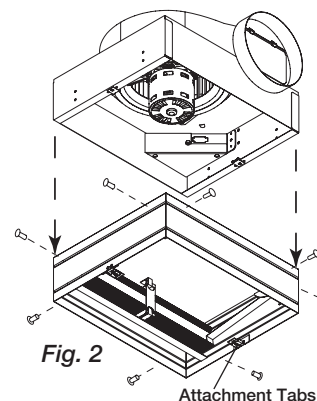

3. To mount the ceiling radiation damper to fan, make sure grille attachment tabs are facing down. Then place the inlet part of the fan into the ceiling radiation damper collar, and use self-tapping sheet metal screws #10x1/2 in. (by others) to screw through the damper collar and into the fan housing, shown in Fig. 2. If the fan/light combination is being used, make sure ceiling radiation damper has an electrical plug in it. The electrical plug must be inserted into the fan. Make sure the electrical wire will not interfere with damper operation, shown in Fig. 3.

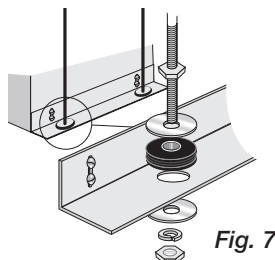
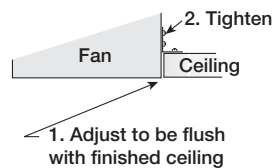
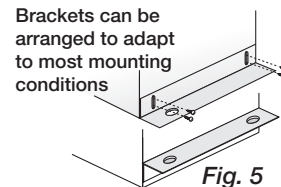
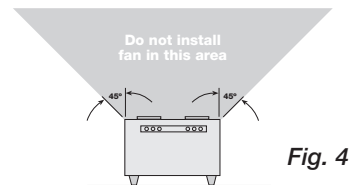
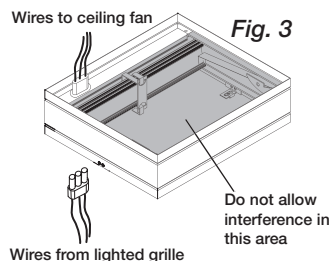

For Hanging Installations: Use Accurex's optional vibration isolator kit Part Number VI Kit. Using the fan's standard adjustable mounting brackets and 10 by 32 threaded rod (by others) hang unit as shown in Fig. 7.

WARNING !

To reduce the risk of fire, electric shock, or injury to persons, observe the following:

- Suitable for use with solid-state speed controls.
- Use this unit only in the manner intended by the manufacturer. If you have questions, contact the manufacturer.
- Before servicing or cleaning unit, switch power off at service panel and lock service disconnecting means to prevent power from being switched on accidentally. When the service disconnecting means cannot be locked, securely fasten a prominent warning device, such as a tag, to the service panel.
- Installation work and electrical wiring must be done by qualified person(s) in accordance with all applicable codes and standards, including fire-rated construction.
- Sufficient air is needed for proper combustion and exhausting of gases through the flue (chimney) of fuel burning equipment to prevent back drafting. Follow the heating equipment manufacturer's guideline and safety standards such as those published by the National Fire Protection Association (NFPA), and the American Society for Heating, Refrigeration and Air Conditioning Engineers (ASHRAE) and the local code authorities.
- When cutting or drilling into wall or ceiling, do not damage electrical wiring or other hidden utilities.
- Acceptable for use over a bathtub or shower when installed in a GFCI protected branch circuit. (Up through size XCR-A390)
- Never place a switch where it can be reached from a tub or shower.
- Ducted fans must always be vented to the outdoors.
- These fans are not recommended for cooking exhaust applications. They are designed primarily for low temperature, clean air applications only. The diagram shows the minimum distance these fans should be placed in relation to cooking equipment.
- Fan/Light combination not to be installed in a ceiling thermally insulated to a value greater than R40.

CAUTION !

- For general ventilating use only. Do not use to exhaust hazardous or explosive materials and vapors.

Installation Recommendations

Install the Fan - continued

3. Slide ductwork over the fan's discharge collar and securely attach it with sheet metal screws. *Make sure the screws do not interfere with damper operation. Check damper to make sure it opens freely.*

Wire the Fan

1. Remove wiring cover. If fan/light combination is being used, make sure the fan plug is connected to the fan receptacle and the light plug is connected to the light receptacle, shown in Fig. 8. Using proper wire connectors, wire the fan as shown in Fig. 9a. For wiring of light proceed to Fig. 9b.

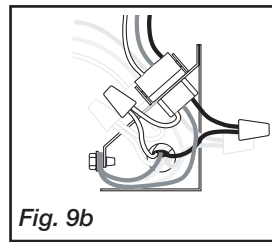
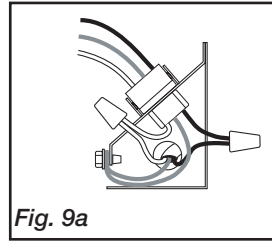
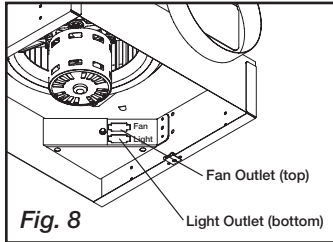

115 & 277 Volt
Black wire is "Hot"
White wire is "Neutral"
Green wire is "Ground"

220 - 240 Volt
Black wire is "Hot"
White wire is "Hot"
Green wire is "Neutral/Ground"

2. Push all wiring into the unit's cover and replace wiring cover.

Attach the Grille

1. If lighted grille is being used, plug wire into fan socket.

If lighted grille and ceiling radiation damper are being used, plug wire from lighted grille into ceiling radiation damper socket. Do not plug wire directly into the fan socket. Make sure the wire does not interfere with the ceiling radiation damper operation.

2. Attach grille with two screws provided. Make sure not to over tighten, over tightening will damage grille.

3. Slide attachment screw covers over the attachment screws, shown in Fig. 10.

4. If lighted grille is being used, install light bulb(s) into light socket(s). For incandescent lights, use maximum 100 watt bulb (by others). For fluorescent lights, use only Accurex's Part Number 382854, provided, 13 watt flicker resistant light bulbs. For replacement bulbs please contact Accurex at phone number 1-800-355-5354.

5. If lighted grille is being used, snap lens into place, by pushing on the outside edges of lens, shown in Fig. 11. To remove lens, use small screw driver and pry on one side of lens.

6. Turn on power and check fan and light operation.

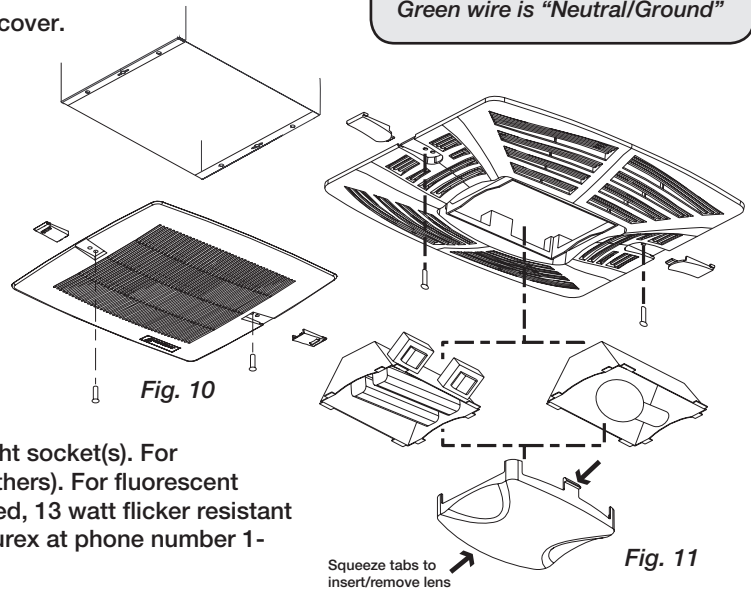

General Maintenance Suggestions

Model XCR/XIR ceiling exhaust fans require very little maintenance. But since small problems over time left unchecked could lead to loss of performance or early motor failure, we do recommend that the unit be inspected periodically (once or twice a year).

The fan motor and wheel should be checked for dust and dirt accumulations. Dirt buildup can lead to loss of performance and motor overheating. Cleaning can be accomplished by brushing off any dust that may have accumulated. Even filtered units can accumulate build-up and should be checked when cleaning filters.

The motor should be checked for lubrication at this time. Lubricate only those motors which have an oil hole provided. A few drops of all purpose oil (SAE 20) will be sufficient.

WARRANTY

Accurex warrants this equipment to be free from defects in material and workmanship for a period of three years from the date of purchase. Any units or parts which prove to be defective during the warranty period will be replaced at our option when returned to our factory, transportation prepaid. Motors are warranted by the motor manufacturer for a period of one year. Should motors furnished by Accurex prove defective during this period, they should be returned to the nearest authorized motor service station. Accurex will not be responsible for any removal or installation costs.

As a result of our commitment to continuous improvement, Accurex reserves the right to change specifications without notice.

ACCUREX
ENGINEERED RESTAURANT SYSTEMS
P.O. Box 410 Schofield, WI 54476
Phone: 888.333.1400 Fax: 715.241.6191
www.accurex-systems.com